

J4q282-p7 FC f150

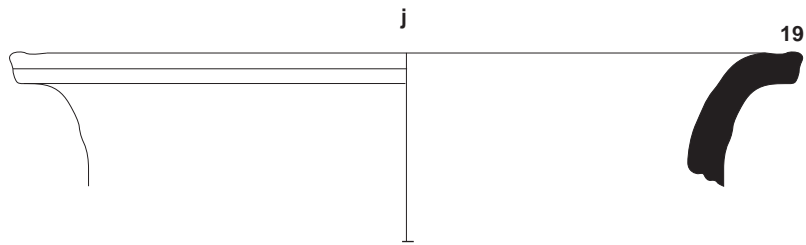

J6q272-p1 FC f164

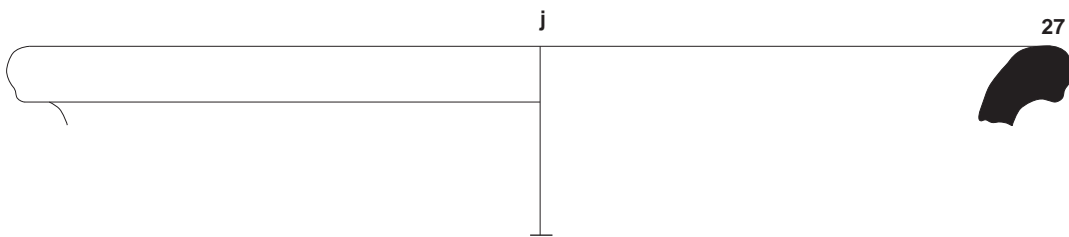

J6q272-p2 CH f164

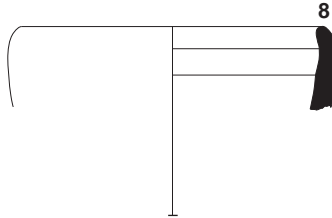

J4q281-p12 FC f150

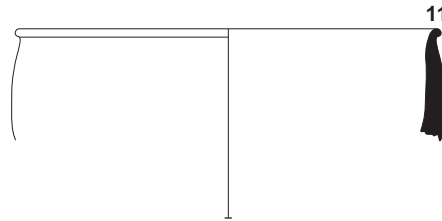

J4q281-p8 f150

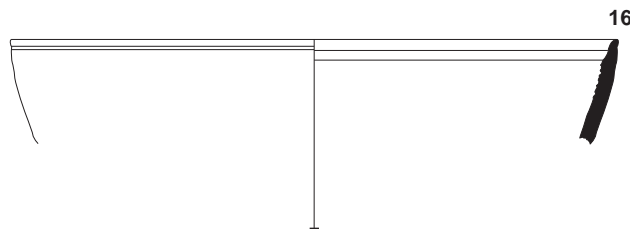

J4q282 -p13 WS f150

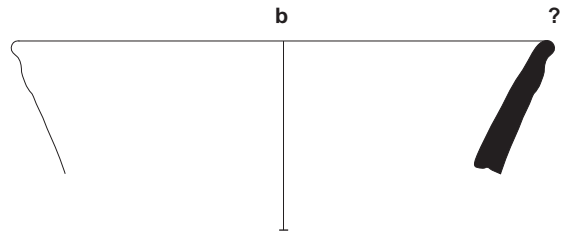

J4q282-p3 FC f150

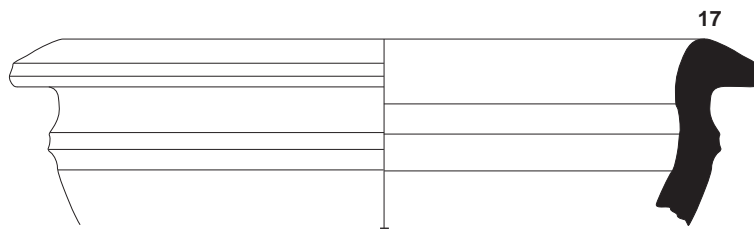

J4q281-p3 CH f150

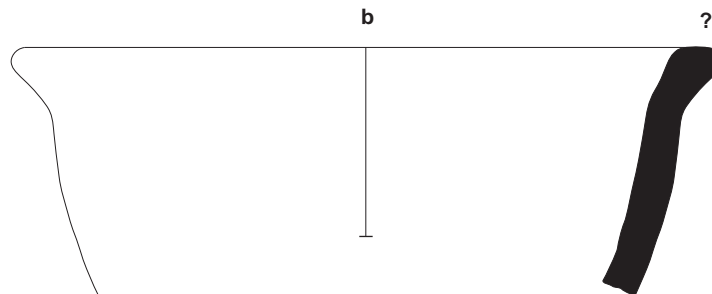

J4q281-p4 RC f150

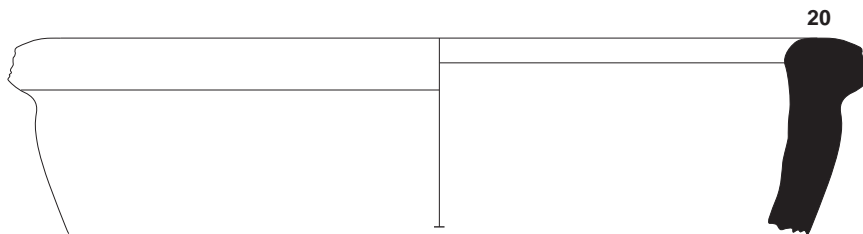

J4q282-p4 CH f150

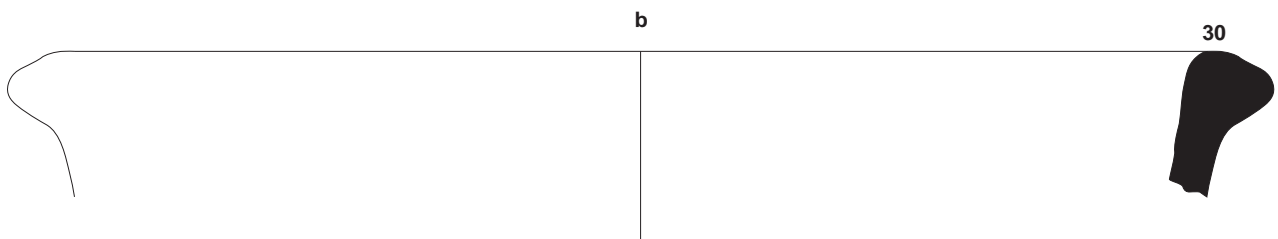

J4q282-p6 CH f150

Deep Bowls

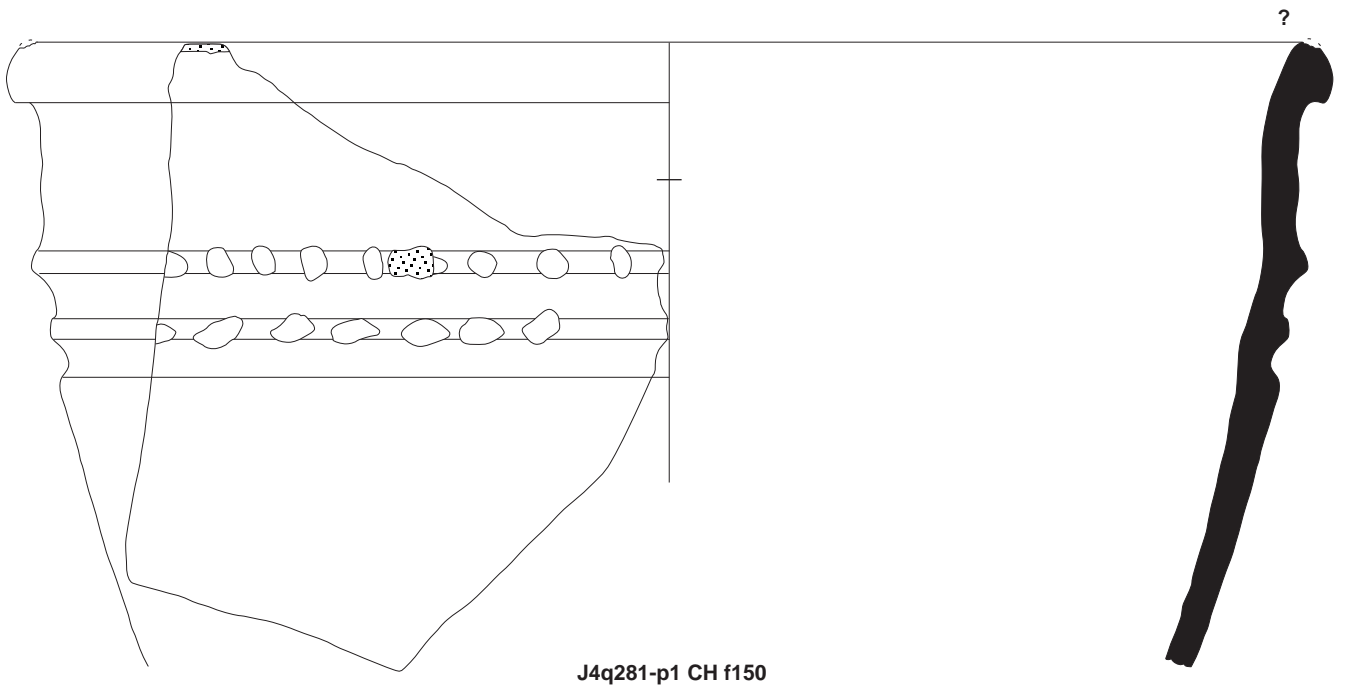
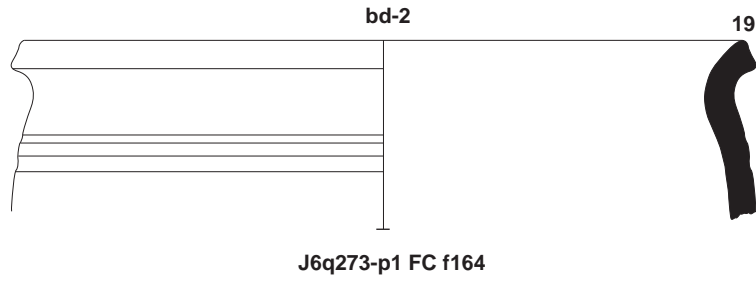

Cups

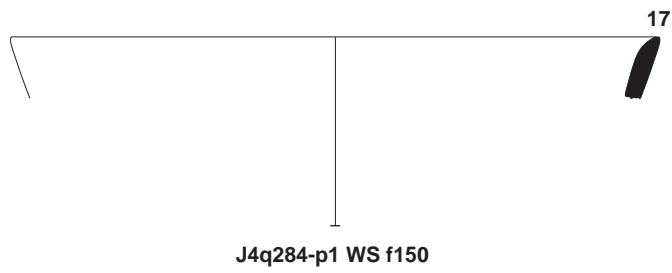
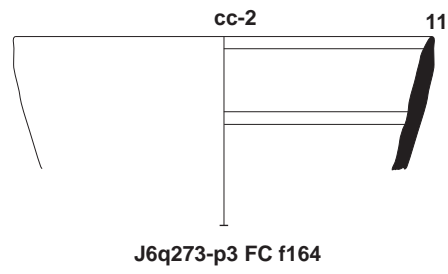
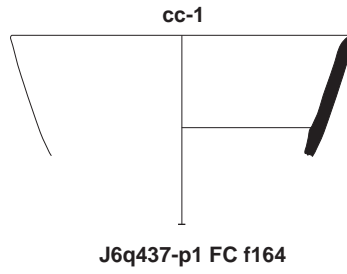

J4b1 f150_J6f164

Bases

p.6 of 7

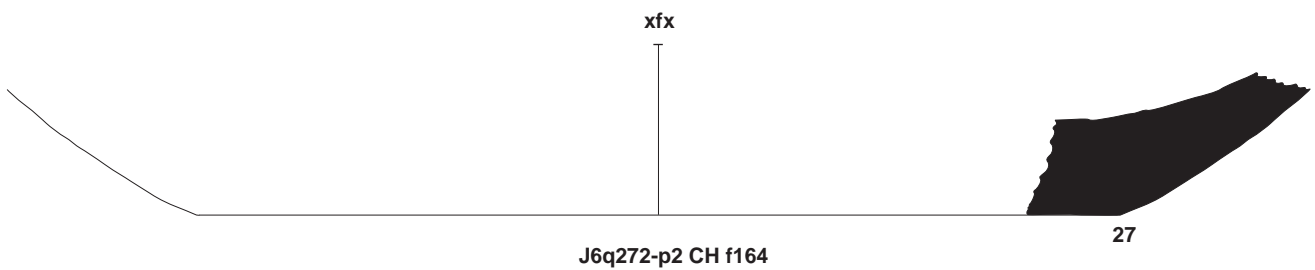
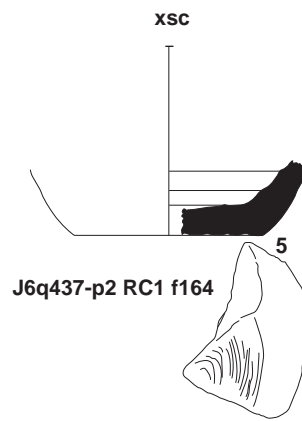
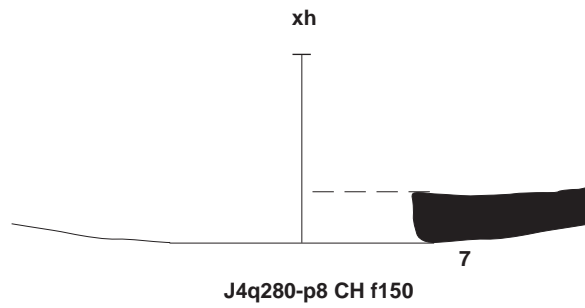
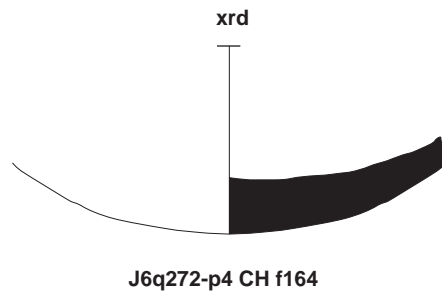

Other shapes



J6q272-p75 CH f164

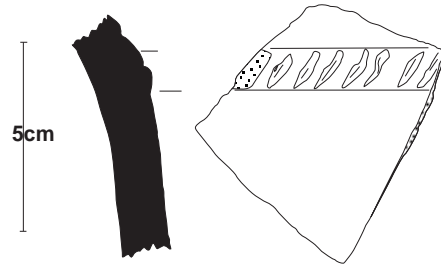

J6q272-p73 CH f164

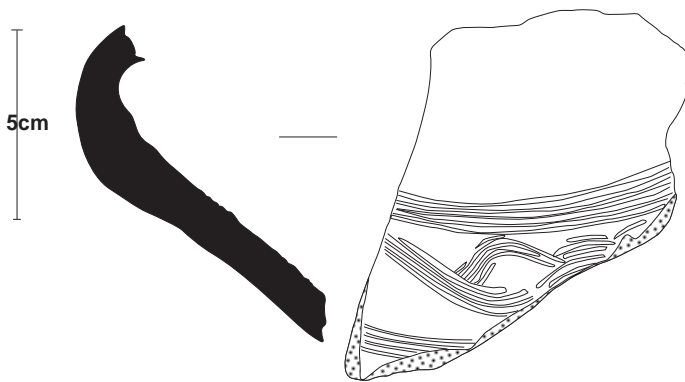

J6q272-p3 CH f164

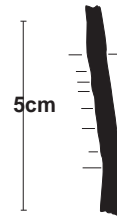

J4q281-p70 f150

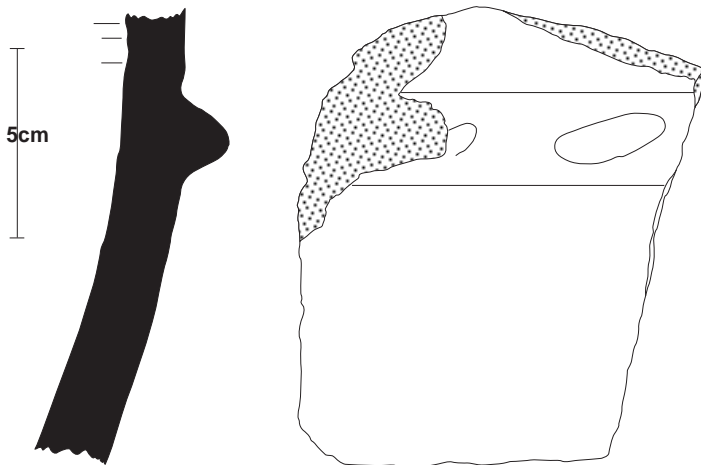

J6q272-p74 CH f164



J4q281-p71 RC f150